



JST12E-1200SW 12A TRIAC

Rev.A.1.1

DESCRIPTION:

The JST12E-1200SW triac is suitable for general purpose AC switching. It can be used as an ON/OFF function in applications such as heating regulation, induction motor starting circuits, for phase control operation in light dimmers, motor speed controllers. JST12E-1200SW snubberless triac is especially recommended for use on inductive loads. It can be driven directly through the MCU I/O port. Package TO-263 is RoHS compliant.

ORDERING INFORMATION

	J	ST	12	E	-1200	SW	-/
JieJie Microelectronics Co., Ltd.		Triacs IT(RMS):12A		E:TO-263		SW:IGT1-3 010mA	Blank:Tube -TR:Tape &Reel
					1200:VDRM /VRRM 11200V		

MARKING

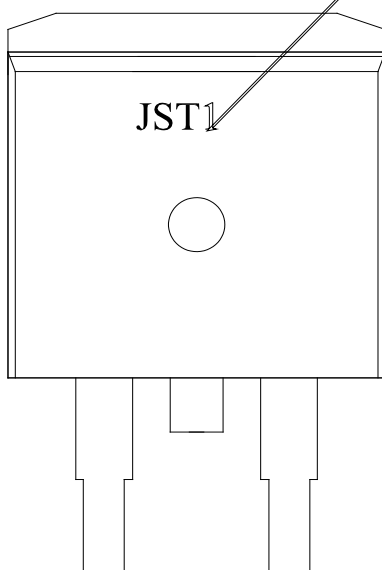

FIG.1: Maximum power dissipation versus RMS on-state current

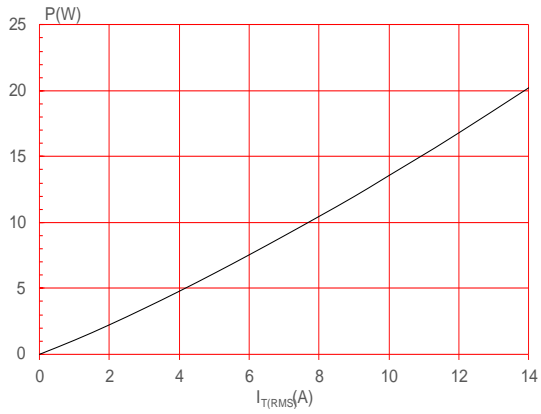

FIG.2: RMS on-state current versus case temperature

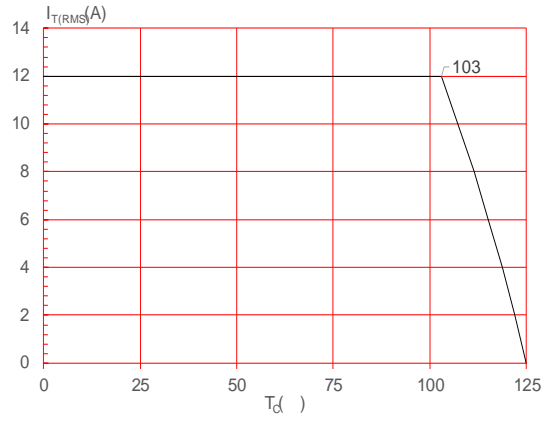

FIG.3: RMS on-state current versus ambient temperature (printed circuit board FR4,copper WKL FNQHVV P IXOO F\FOH

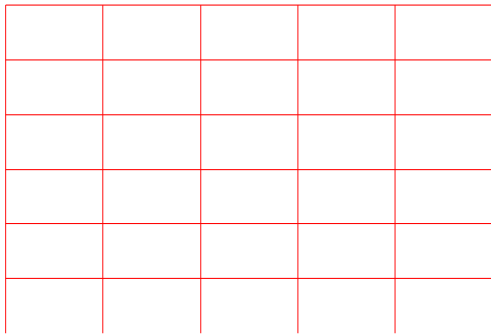

FIG.4: Surge peak on-state current versus number of cycles

FIG.7: Relative variations of gate trigger current, holding current and latching current versus junction temperature

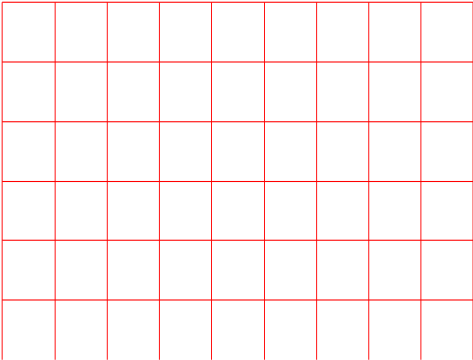
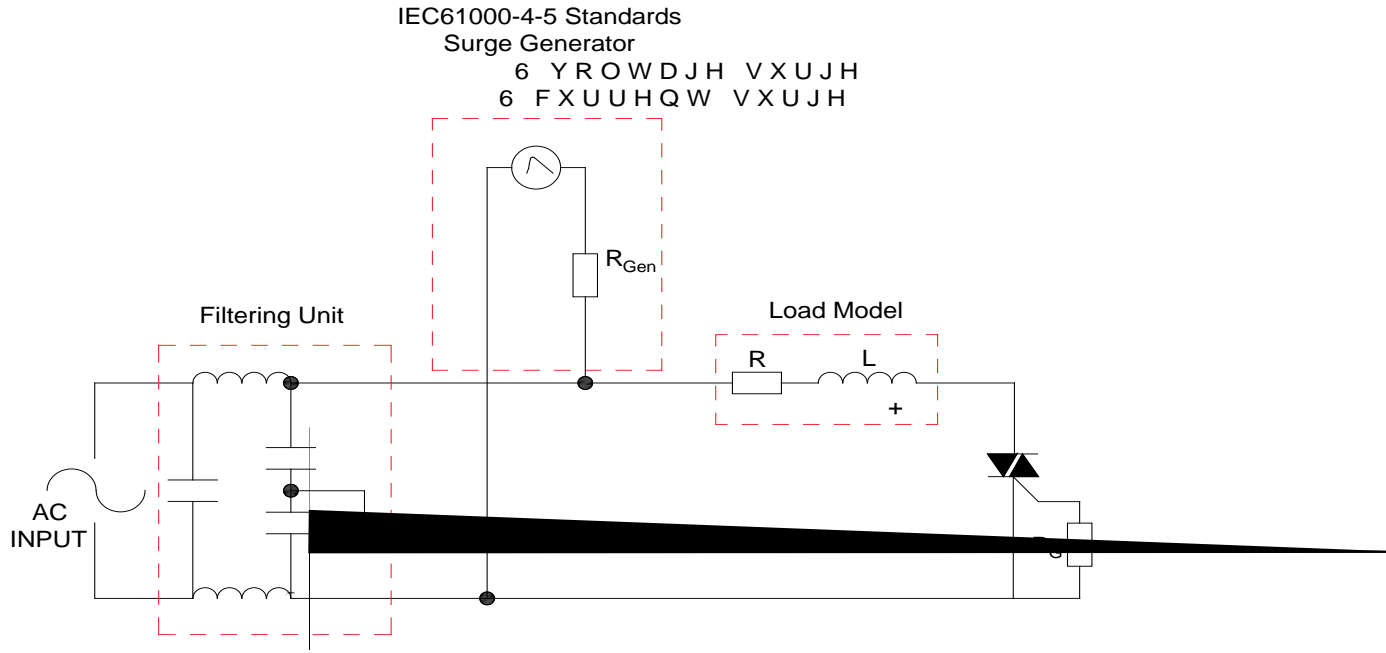

FIG.8 ÖTest circuit for inductive and resistive loads to IEC-61000-4-5 standards



ORDERING INFORMATION

Order code	Voltage V_{DRM}/V_{RRM} (V)	IGT(mA)	Package	Base qty. (pcs)	Delivery mode
		H- I- J			
JST12E-1200SW	1200	10	TO-263	50	Tube
JST12E-1200SW-TR				800	Tape & Reel

Document Revision History

Date	Revision	Changes
Apr.11, 2023	A.1.0	Last updated
Oct.20, 2025	A.1.1	Revise PACKAGE MECHANICAL DATA

DELIVERY MODE

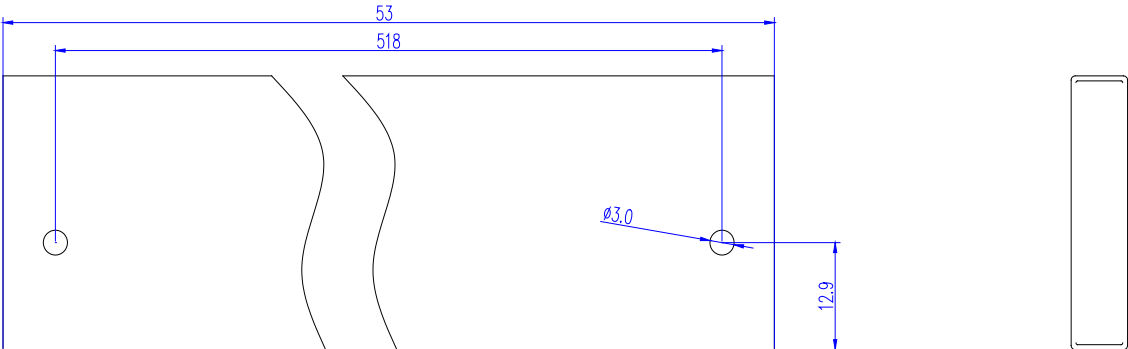

Information furnished in this document is believed to be accurate and reliable. However, Jiangsu JieJie Microelectronics Co., Ltd. assumes no responsibility for the consequences of use without consideration for such information nor use beyond it. Information mentioned in this document is subject to change without notice, apart from that when an agreement is signed, Jiangsu JieJie complies with the agreement.

Products and information provided in this document have no infringement of patents. Jiangsu JieJie assumes no responsibility for any infringement of other rights of third parties which may result from the use of such products and information. This document supersedes and replaces all information previously supplied.

 is a registered trademark of Jiangsu JieJie Microelectronics Co., Ltd.

Copyright © 2025 Jiangsu JieJie Microelectronics Co., Ltd. All rights reserved.