



**JST08X-1100CW 8A TRIAC**

Rev.A.1.1

**DESCRIPTION:**

The JST08X-1

Peak pulse voltage ( $T_j=25$ ; non-repetitive, off-state; FIG.7)	$V_{pp}$	4	kV
--	----------	---	----

**ELECTRICAL CHARACTERISTICS** ( $T_j=25$  unless otherwise specified)

Symbol	Test Condition	Quadrant	Value		Unit
$I_{GT}$	$V_D=12V R_L=33$	- -	MAX.	35	mA
$V_{GT}$		- -	MAX.	1	V á

$V_D=V$  =125

=3-3

L I

ORDERING INFORMATION

	<u>J</u>	<u>ST</u>	<u>08</u>	<u>X</u>	<u>-1100</u>	<u>CW</u>
JieJie Microelectronics Co., Ltd.	CS		<u>I<sub>T(RMS)</sub>:8A</u>			<u>CW:I<sub>GT1-3</sub> 35mA</u>
			<u>X:TO-220F(Ins)</u>			<u>1100:V<sub>DRM</sub>/V<sub>RRM</sub> 1100V</u>

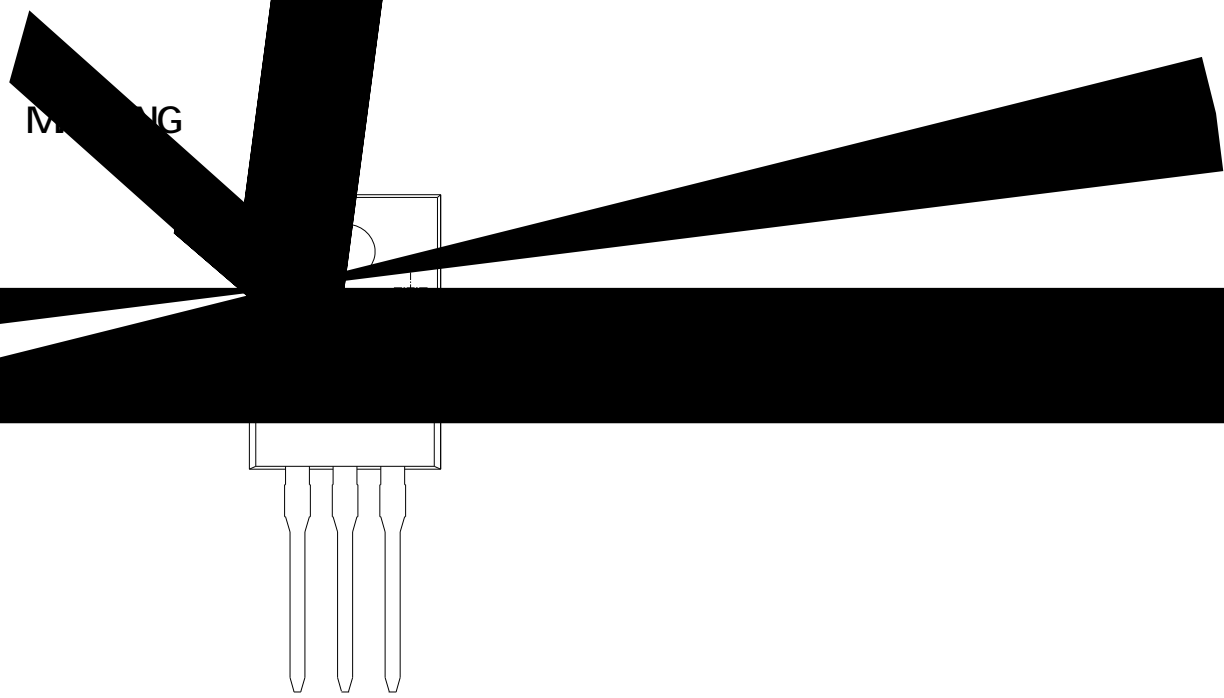

**FIG.1:** Maximum power dissipation versus RMS on-state current

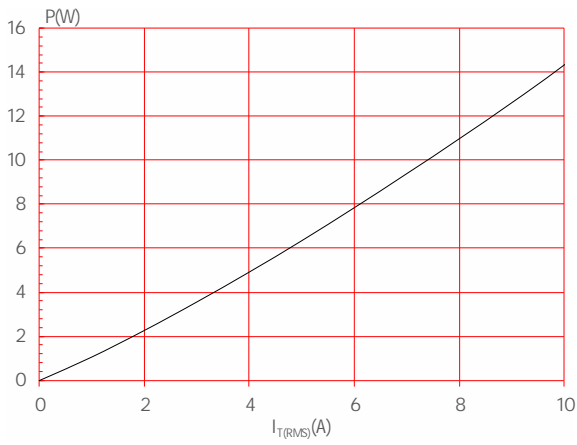

**FIG.2:** RMS on-state current versus case temperature

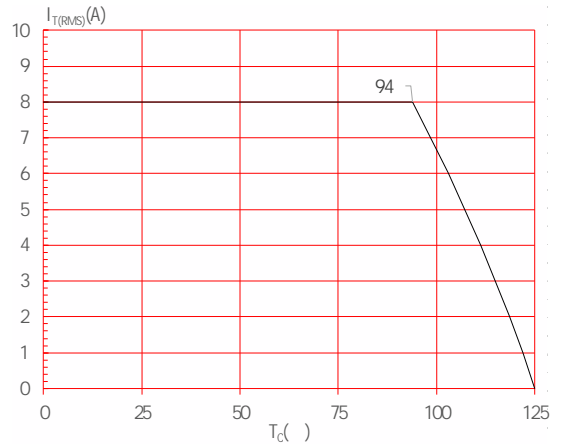

**FIG.3:** Surge peak on-state current versus number of cycles

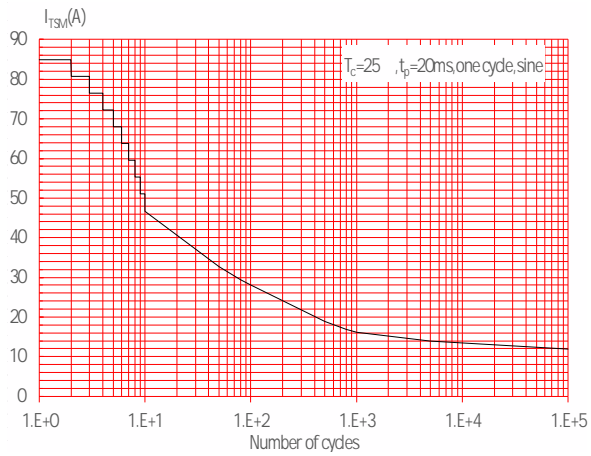

**FIG.4:** On-state characteristics

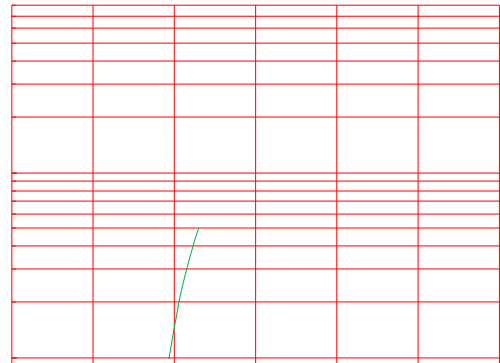
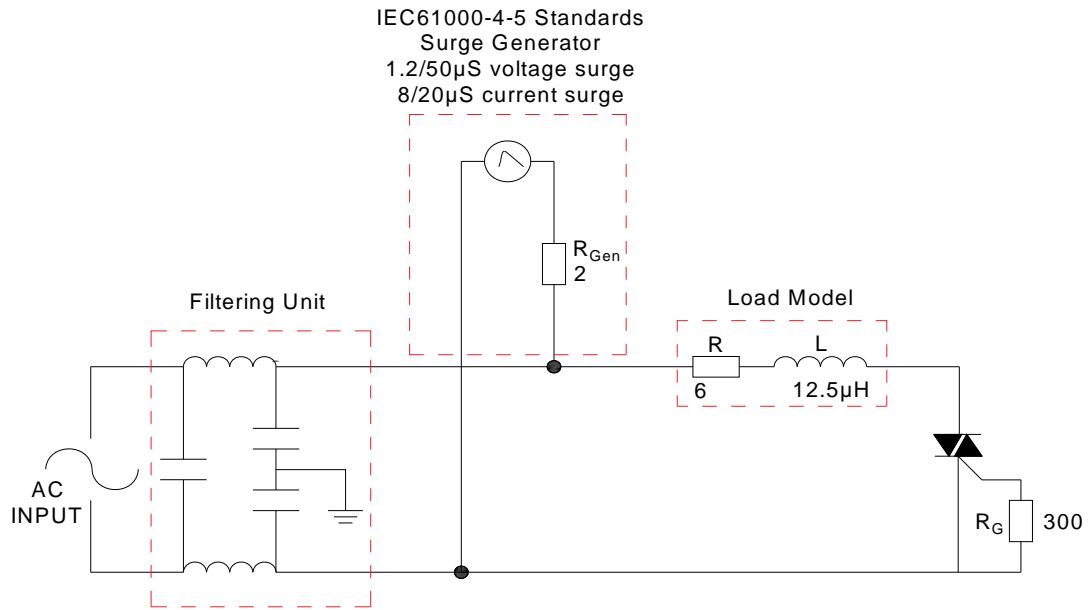

FIG.7 Test circuit for inductive and resistive loads to IEC-61000-4-5 standards



**ORDERING INFORMATION**

Order code	Voltage V <sub>DRM</sub> /V <sub>R<sub>RRM</sub></sub> (V)	IGT(mA)	Package	Base qty. (pcs)	Delivery mode
		- -			
<b>JST08X-1100CW</b>	<b>1100</b>	<b>35</b>	<b>TO-220F(Ins)</b>	<b>50</b>	<b>Tube</b>

**Document Revision History**

Date	Revision	Changes t	1	1	BDse
------	----------	-----------	---	---	------

PACKAGE MECHANICAL DATA

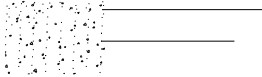

Information furnished in this document is believed to be accurate and reliable. However, Jiangsu JieJie Microelectronics Co., Ltd. assumes no responsibility for the consequences of use without consideration for such information nor use beyond it. Information mentioned in this document is subject to change without notice, apart from that when an agreement is signed, Jiangsu JieJie complies with the agreement.

Products and information provided in this document have no infringement of patents. Jiangsu JieJie assumes no responsibility for any infringement of other rights of third parties which may result from the use of such products and information. This document supersedes and replaces all information previously supplied.

 is a registered trademark of Jiangsu JieJie Microelectronics Co., Ltd.

Copyright © 2025 Jiangsu JieJie Microelectronics Co., Ltd. All rights reserved.