

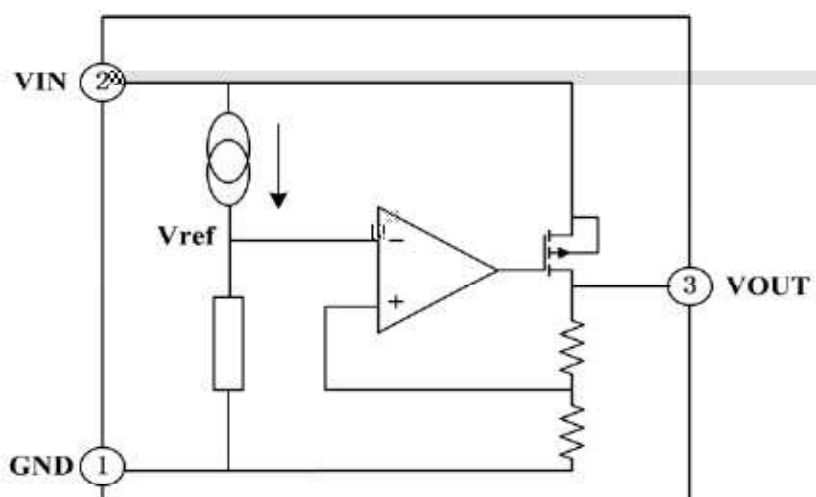

	N	-2L	0	编带	1k盘
	L	L		编带	3k盘
	N	-2L	0	编带	1k
	L				

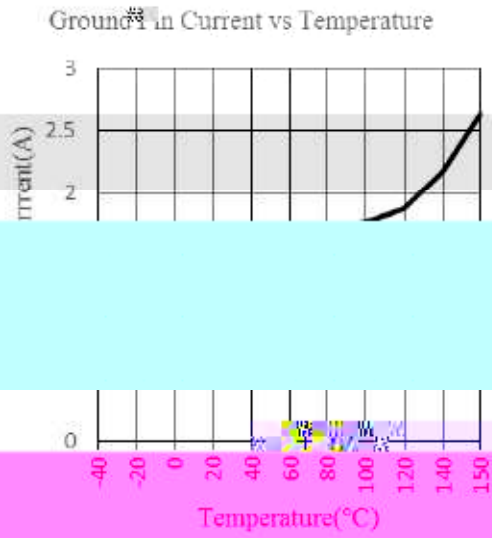

特性曲线

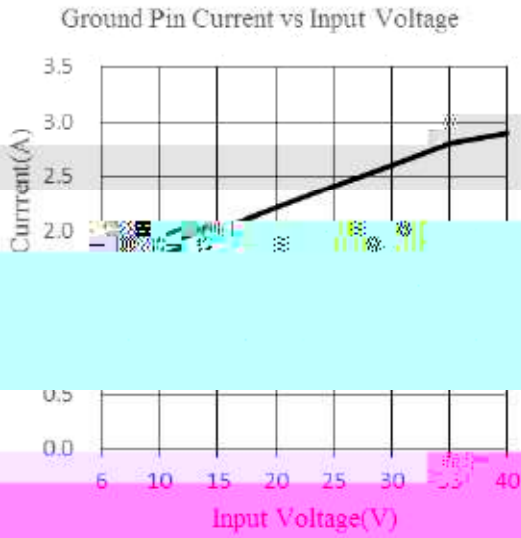

Dropout Voltage vs Output Current

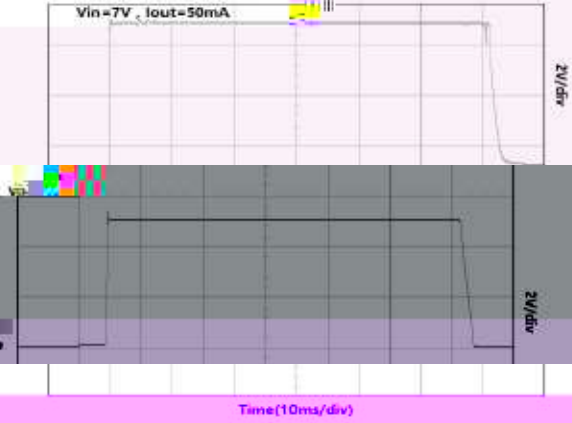
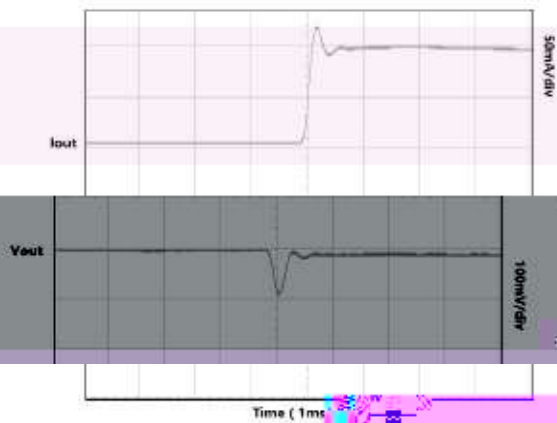
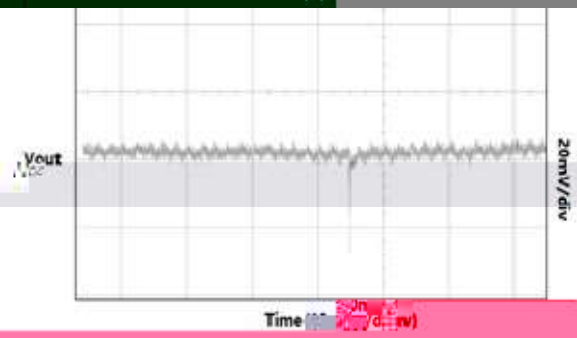
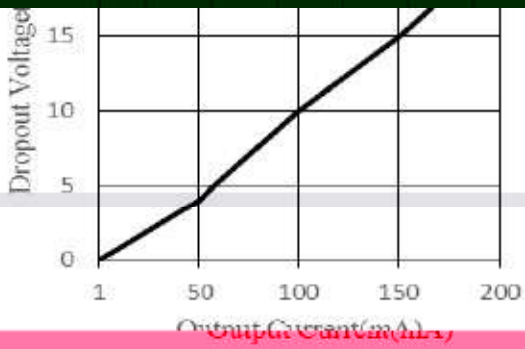

ECTR

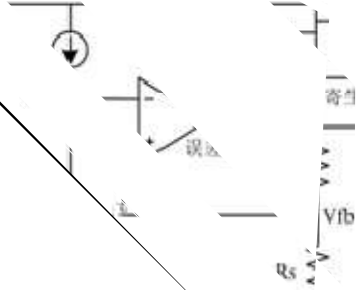

TR

