

Storage Temperature	T _{stg}	-55~+125	
Soldering Temperature	T _{sol}	260	

: μ
:

(Temperature=25°C)

Parameter		Symbol	Condition	Min.	Typ.	Max.	Unit
	Forward Voltage	V _F	I _F =10mA	-	1.2	1.5	V

Input Reverse Current I_R I

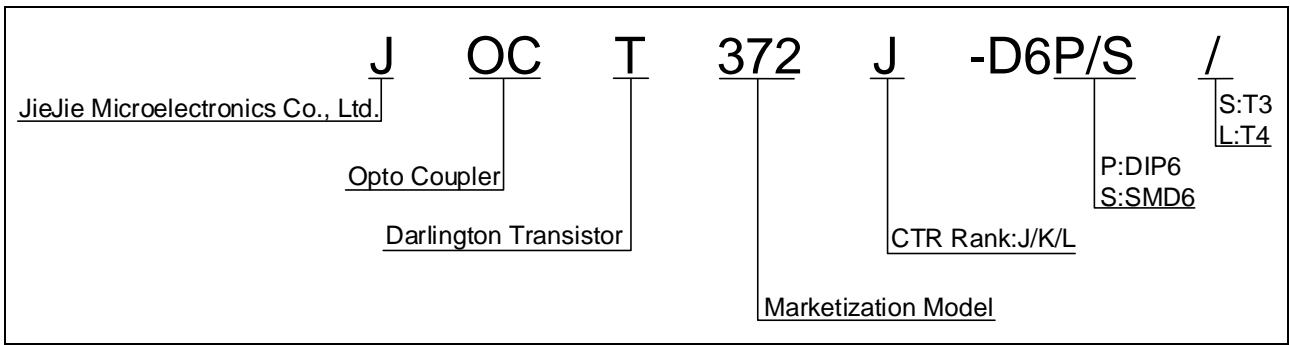

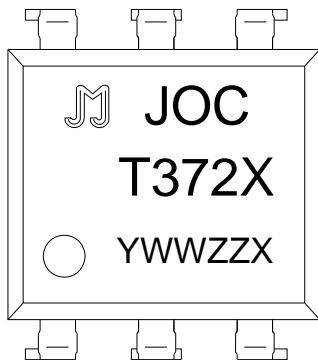

FIG.1: Max. Allowable LED Forward Current vs. Ambient Temperature

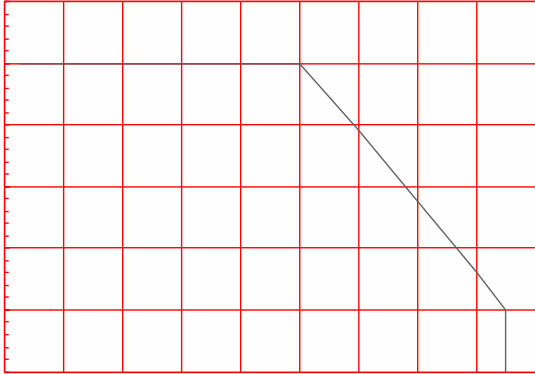
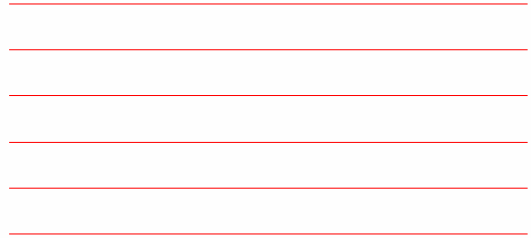
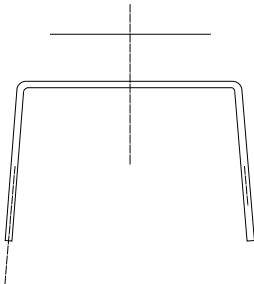

FIG.2: Collector Power Dissipation vs. Ambient Temperature



Standard DIP Type:



Ref.	Dimensions					
	Millimeters			Inches		
	Min.	Typ.	Max.	Min.	Typ.	Max.
D0		1.50	1.60		0.059	0.063
P0	3.90	4.00	4.10	0.154	0.157	0.163
P1	11.90	12.00	.9	0.469	0.472	0.475
P2	1.90	2.00		0.075	0.079	
E	1.65	1.75		0.065	0.069	
F	7.40	7.50		0.291	0.295	
T	0.35	0.40		0.014	0.016	
W	15.70	16.00	16.30	0.618	0.630	0.642

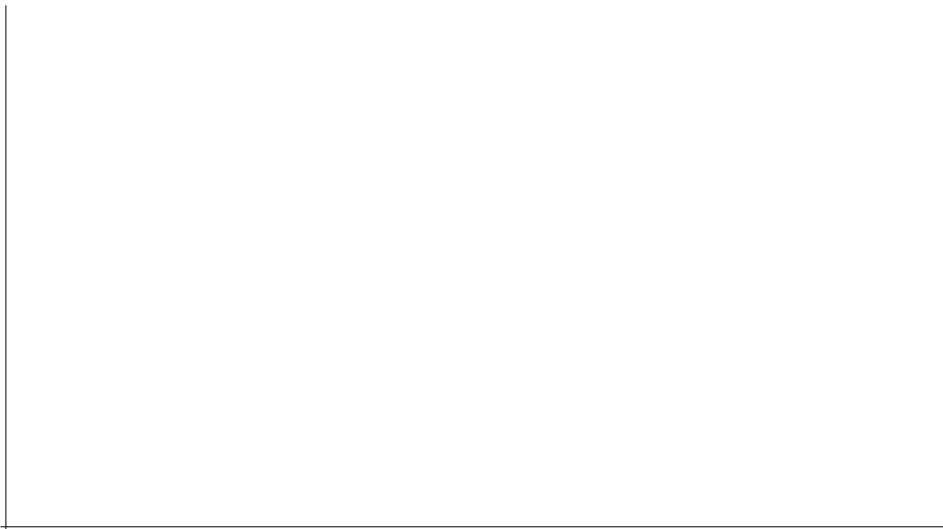
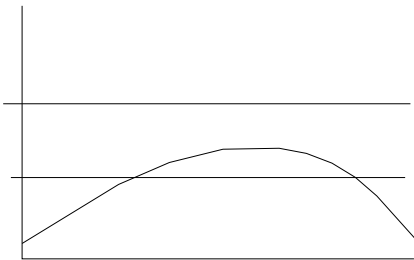
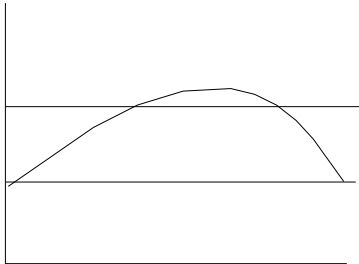

Note:

1. Reflow soldering is recommended at the temperatures and times shown, no more than three times.
2. Avoid direct contact between the epoxy body and any tools or surfaces exceeding its maximum storage temperature.
3. Application of pressure on the epoxy body is prohibited at elevated temperatures. In specific scenarios, any applied force must not exceed 2.5N.
4. Ensure the component has cooled to ambient temperature before proceeding with any subsequent manufacturing steps.
5. The component has a shelf life of one year when stored under standard conditions.
6. Recommend storage Temp.: 0~40°C;
Recommend storage humidity: <60%;
MSL level: MSL 1

Information furnished in this document is believed to be accurate and reliable. However, Jiangsu JieJie Microelectronics Co., Ltd. assumes no responsibility for the consequences of use without consideration for such information nor use beyond it. Information mentioned in this document is subject to change without notice, apart from that when an agreement is signed, Jiangsu JieJie complies with the agreement.

Products and information provided in this document have no infringement of patents. Jiangsu JieJie assumes no responsibility for any infringement of other rights of third parties which may result from the use of such products and information. This document supersedes and replaces all information previously supplied.

 is a registered trademark of Jiangsu JieJie Microelectronics Co., Ltd.

Copyright © 2026 Jiangsu JieJie Microelectronics Co., Ltd. All rights reserved.