



JOCMC37C-M4

Rev.A.1.0

DESCRIPTION:

7KH SURGXFWV DUH SLQ RSWLFDQ QHOD\ 7KH GHYLFH F
\$O*D\$V LQIUUDHG HQ\$XWV\QVDGHRG\$WLFDOO\ FRXSOHG WR D
KLJK YROWDJH RXW\$XWLQHDV\$DWRWLF 623 SDFNDJH
7KH GHWHFWRU FRQVLVWV RI D KLJK VSHHG SKRWRYROWDL
DQG GULYHU FLUFXLWUH ZLGH SURGXFWLQJ PHDVXULQJ
DQG WHVWLQJ HTXLSHQD\WHX\$ULWHDQGLRQ PDUNHW
LQG\$VWULDQ PDFKLQHU\ DQG HTXLSPHQW

MAIN FEATURES

- +LJK LVRODWLRFQ
6LQJOH &KDQQHO 1RUPDOO\ &ORVHG 6LQJOH 3ROH 6LQJOH
2SHUDWLQJ WHPSHUJHWXUH WR f&
5(\$&+ 5R+6 FRPSOLDQFH
+%0 + \$ 00 0 &'0 &
&4& DSSURYHG
9'(DSSURYHG
8/ DSSURYHG

ABSOLUTE MAXIMUM RATINGS 7HP SHUDWXUH f&

Table with 4 columns: Parameter, Symbol, Value, Unit. Rows include parameters like)RUZDUG &XUUHQW, 3HDN)RUZDUG &XUUHQW, 5HYHUVH 9ROWDJH, ,QSXW 3RZHU 'LVVLSDWLRQ, /RDG 9ROWDJH, &RQLQXR XV ORD G FXUUHQW, 2XWSXW 3RZHU 'LVVLSDWLRQ, 7RWDO 3RZHU 'LVVLSDWLRQ, ,VRODWLRQ 9ROWDJH.

ORDERING INFORMATION

- LH-LH - 2 & 0 & &

Characteristics Curves

FIG.1: /(' 'URSRXW 9ROWDJH YV \$ P FIG.2 WXWSXW &XUUHQW YV 2XWSXV
7HP SHUDWXUH

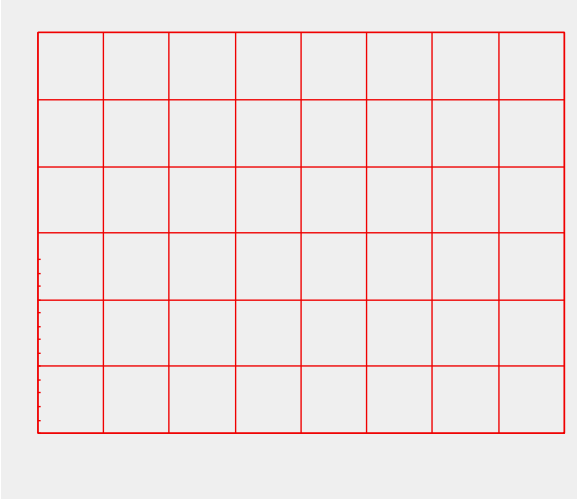

FIG.7: 7XUQ 2Q 7LPH YV \$PELHQW 7HPSHUDWXUH 7HPSHUDWXUH 7LPH YV \$PELHQW 7HPSHUDWXUH

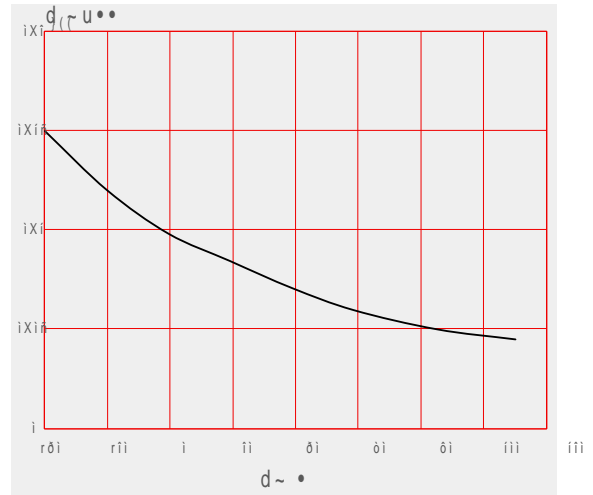
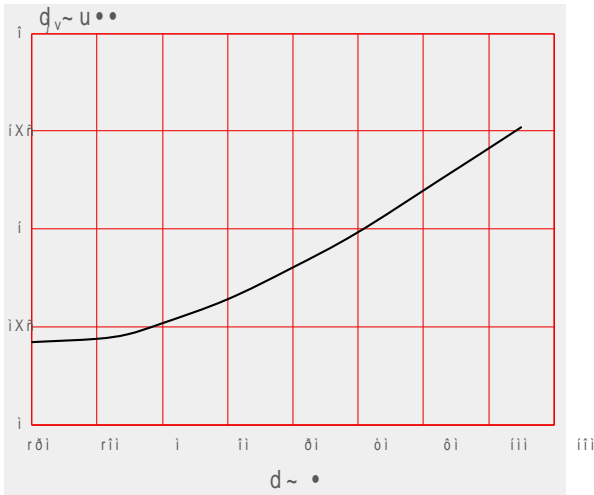

FIG.9: 7XUQ 2Q 7LPH YV /(')RUZDUG FIG.10: 7XUQ 2II 7LPH YV /(')RUZDUG & XUHQW

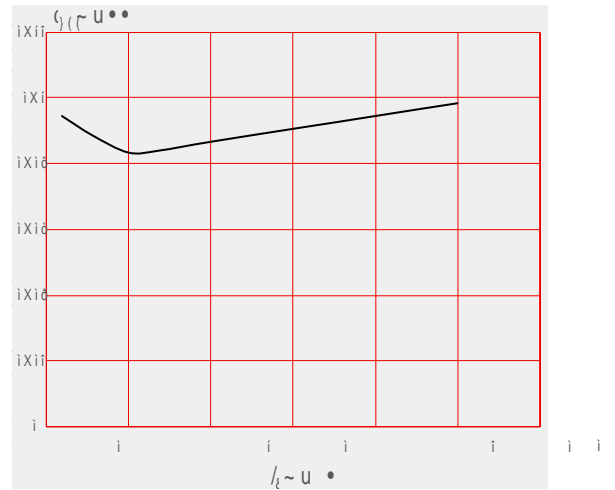
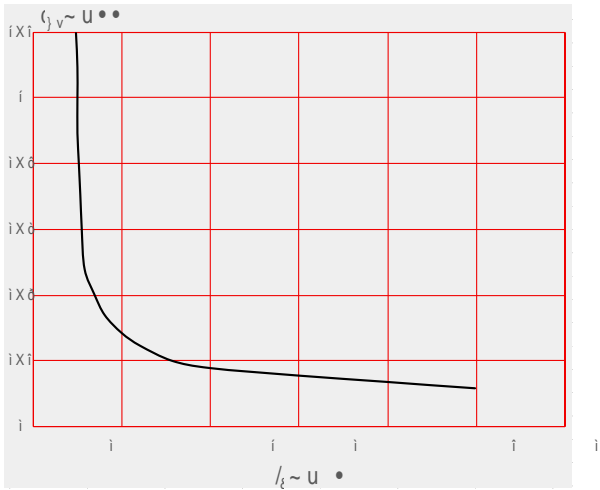
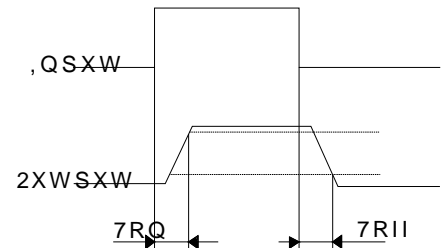
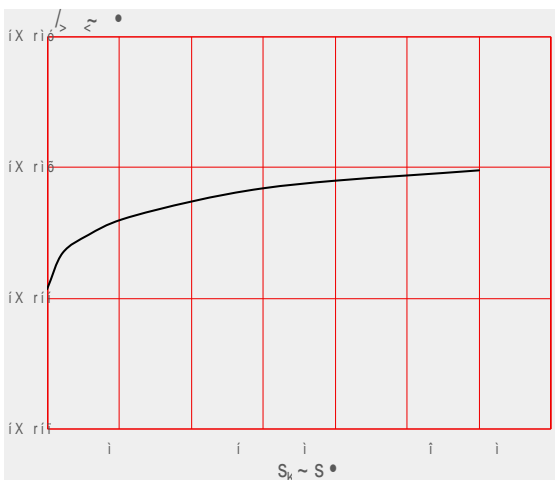
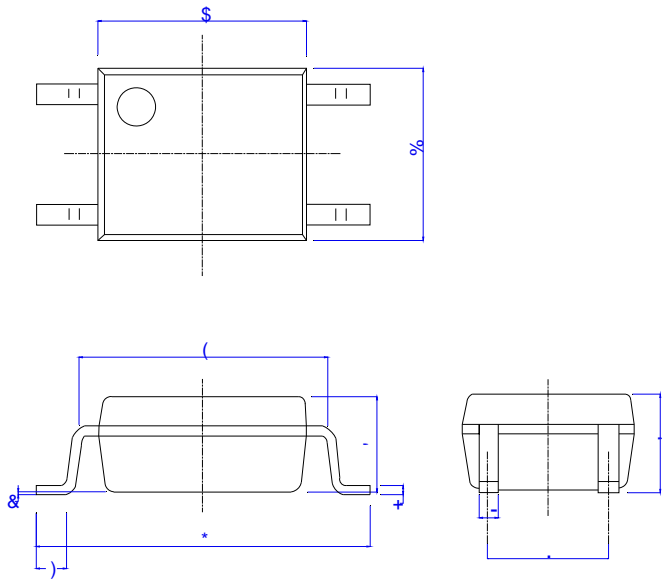

FIG.11: 2II 6WDWH /H DQDW HY & XUHQW 9 FIG.12: Turn on/Turn off time



Package Dimension (Unit: mm)



5HI	'LPHQVLRQV					
	0LOOLPHWHUV			,QFKHV		
	0LQ	7\S	0D[0LQ	7\S	0D[
\$						
%						
&						
'						
(
)						
*						
+						
,						
-						
.						

RECOMMENDED SOLDER MASK (Dimensions in mm unless otherwise stated)

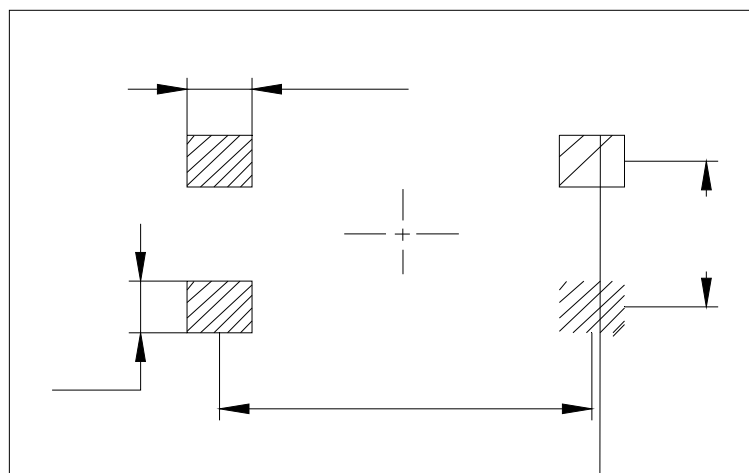

CARRIER TAPE SPECIFICATIONS (Dimensions in mm unless otherwise stated)

Option None

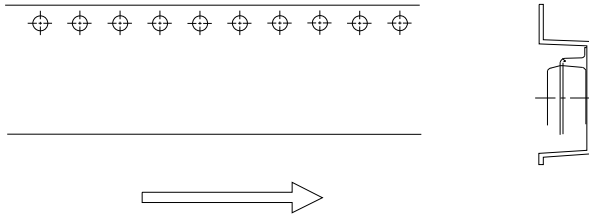

REFLOW INFORMATION

7 HP SHUDMUH

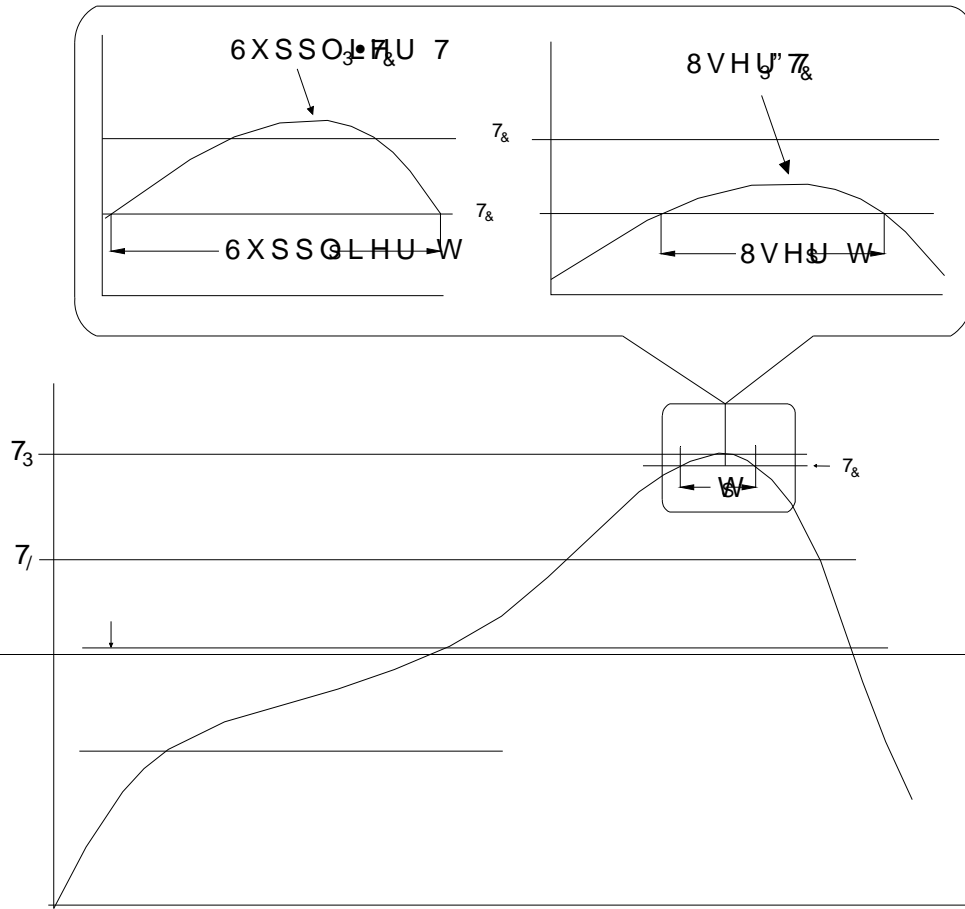

1RWH

5HIORZ VROGHULQJ LV UHFRPPHQGHG DWRVGHQRHPSHHDWKXUHWKDU

\$YRLG GLUHFV FRKWDHFRBEEPRZHQQWRXLD DFRUV H[FHHGLQJ LWV PD
VWRUDJH WHPSHUDWXUH

\$SSOLFDWLRQ RIIHSUHVXELURKQZWSOHGDDWHG WHPSHUDWXUHV ,QV
VFHQDULRV DQHPSVOLHQRWRHFFHHG 1

(QVXUH WKH FRPSRQHQW KDV FRROHG SMRRDREHGHQDQZVHPESHUTXMXQ
PDQXIDFWXULQJ VWHSV

7KH FRPSRQHQW KH BV DQVKHDIUOZKHQVWD RGHG G F B Q G LWLRQV

5HFRPPHQG VWRUDJH 7HPS a f&

5HFRPPHQG VWRUDJH KXPLGLW\

06/ OHYHO 06/

,QIRUPDWLRQ IXUQXFKHQ/ LQ V/KOVLHGRHFG WR EH DFFXUDWH D
-LDQJVVX -LH-LH 0L RRRHOWHGF WDVROXLFHV CLRUVUHRUSRQKHLERQVHT
RI XVH ZLWKRXW FRQVLGHUDWLRQ IRG MWFKQIQURPDPDWRLOQ
LQ WKLV GRFXPHQFKLQJYXZELMHKFRXWRQRWLFH DSDUW IURP V
VLJQHG -LDQJVVXOLHIVLZILFRKPWKH DJUHHPHQW

3URGXFVW DQG LQIRUPDWLRQ SURYLGHLQJLQPHQKWRG RSDXPH
-LDQJVVX -LH-LH DVVXIPHLVQWR\URVSDQVLQIULQJHPPHQW RI RW
ZKLFK PD\ UHVXOW IURP WKH XVH RI VFKLW SURFXPHQW DQGS HL
DQG UHSODFHV DOO LQIRUPDWLRQ SUHYLRXVO\ VXSSOLHG

 LV D UHJLVWHUHGDQJJDGHLPHDUN RUF-URHOWHFWURQLFV & R
&RS\ULJKW -LDQJVVX -LH-LH CLV RRRHOWHFGVSPDQGLJKWV UHVH