



JOCHA22B-L5X Series

Rev.A.1.0

The products are 2MBd high-speed opto-couplers. The device is a small-outline coupler suitable for surface-mount assembly. It consists of a high-output-power infrared LED optically coupled to a high-speed photodiode-transistor chip. It is housed in the LSOP5 and LSOP5W package and guarantees a creepage distance of 5 mm, a clearance of 5 mm and an insulation thickness of 0.4 mm. Therefore, it meets the reinforced insulation class requirements of international safety standards. The products are widely used in programmable controllers, industrial inverters and switching power supplies.

High isolation 5000 VRMS

High speed – 2MBd typical

Operating temperature range - 40°C to 110°C

REACH & RoHS compliance

HBM: H3A; MM: M4; CDM: C3

CQC approved

V

	Output Voltage	V_o	20	V
	Output Current	I_o	8	mA
	Output Power Dissipation	P_o	100	mW
Total Power Dissipation		P_{tot}	200	mW
Isolation Voltage		V_{iso}	5000	Vrms
Operating Temperature		T_{opr}	- ~110	
Junction Temperature		T_j	125	
Storage Temperature		T_{stg}	-55~125	
Soldering Temperature		T_{sol}	260	

: 100 μ s pulse, 100Hz frequency

: AC for 1minute, R.H.=40~60%

(Temperature=25°C)

Parameter		Symbol	Condition	Min.	Typ.	Max.	Unit
Input	Forward Voltage	V_F	$I_F=10mA$	-	1.35	1.6	V
	Reverse Current	I_R	$V_R=6V$	-	-	1	μA
	Input Capacitance	C_{in}	$V=0, f=1MHz$	-	60	-	pF
Output	High Level Output Current	I_{OH}	$I_F=0mA, V_{CC}=5.5V, V_O=5.5V$	-	3	500	nA
			$I_F=0mA, V_{CC}=15V, V_O=15V$	-	-	50	μA
	Low Level Supply Current	I_{CCL}	$I_F=10mA$	-	-	1.3	mA
	High Level Supply Current	I_{CCH}	$I_F=0mA$	-	-	1.3	mA
	Logic Low Output Voltage	V_{OL}	$I_F=16mA, I_o=2.4mA, V_{CC}=4.5V$	-	-	0.4	V
	Isolation Resistance	R_{iso}	DC500V 40~60%R.H.	10^{12}	10^{14}	-	
	Floating Capacitance	C_{io}	$V=0, f=1MHz$	-	0.8	-	pF
	Switching Characteristics	LED Trigger Current	I_{FT}	$I_o=0.75mA, V_o=0.8V$	-	-	5

	Propagation Delay Time to Logic Low	TPHL	$I_F=0$ 10mA, $R_L=20k$, $C_L=100pF$	30	150	400	ns
			$I_F=0$ 10mA, $R_L=20k$, $C_L=10pF$	-	70	-	ns
	Propagation Delay Time to Logic High	TPLH	$I_F=10$ 0mA, $R_L=20k$, $C_L=100pF$	150	350	550	ns
			$I_F=10$ 0mA, $R_L=20k$, $C_L=10pF$	-	110	-	ns
	Common Mode Transient Immunity at Logic High	CM _H	$I_F=0mA$, $V_{CM}=1500Vpp$, $R_L=20k$	± 20	± 25	-	kV/ μs
	Common Mode Transient Immunity at Logic Low	CM _L	$I_F=10mA$, $V_{CM}=1500Vpp$, $R_L=20k$	± 20	± 25	-	kV/ μs

J	OC	H	A	2	2	B	-L5X	/
JieJie Microelectronics Co., Ltd.	Opto Coupler	High speed	Single OC	10V	V _{CC}	35V	I _{FT} 5mA	2MBd high speed
								None:T1 R:T2
								None:LSOP5 W:LSOP5W

None/R	3000 Units/Reel

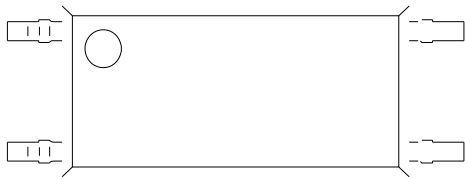

FIG.1: Forward Current vs. Forward Voltage

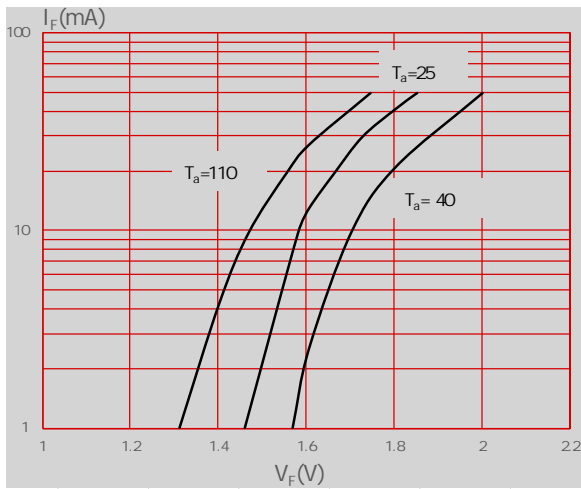

FIG.2: High Level Output Current vs. Ambient Temperature

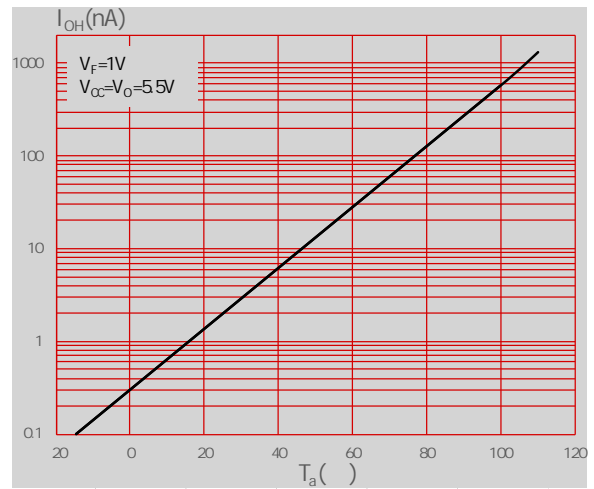

FIG.3: Output Current vs. Forward Current

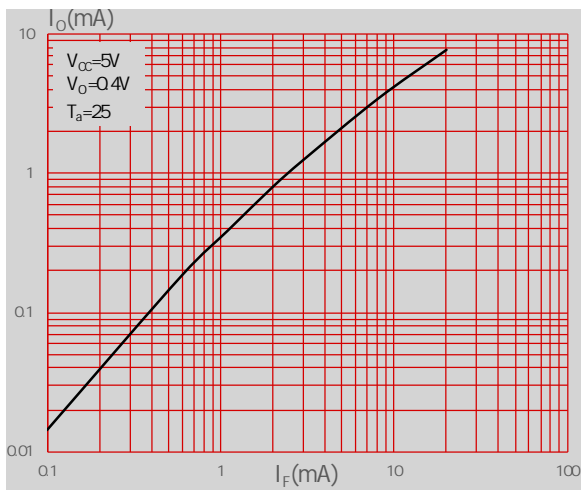

FIG.4: Threshold Input Current vs. Ambient Temperature

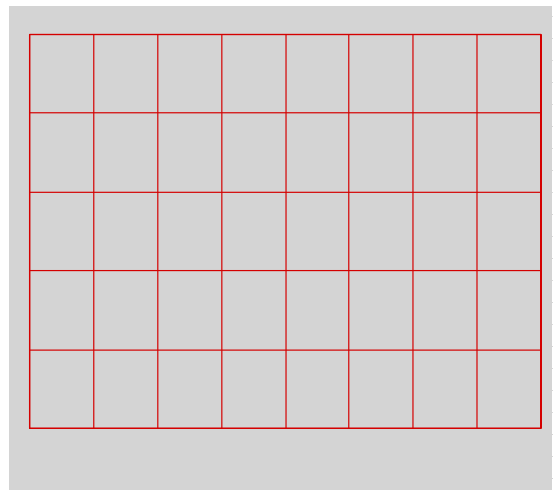

FIG.7: Propagation Delay vs. Load Resistance

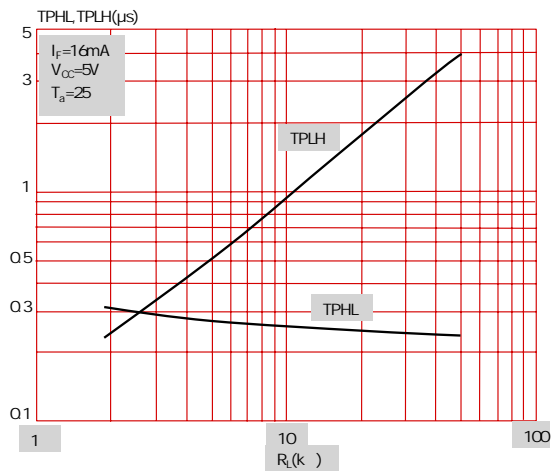

FIG.8: Propagation Delay vs. Ambient Temperature

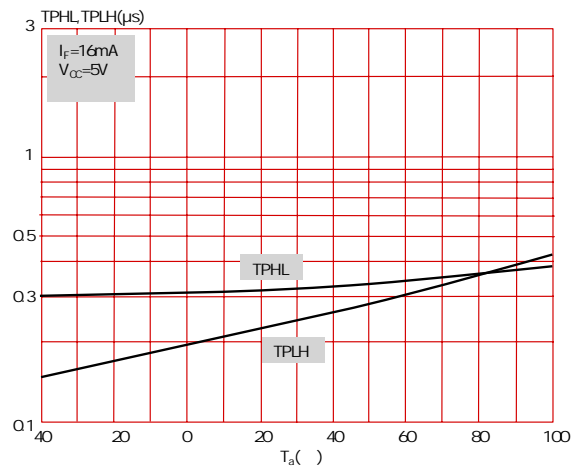
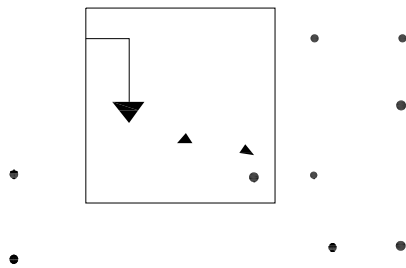
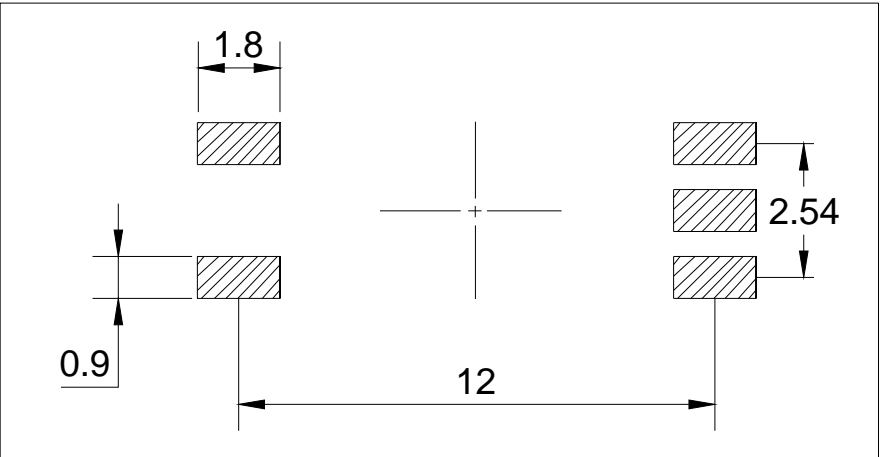
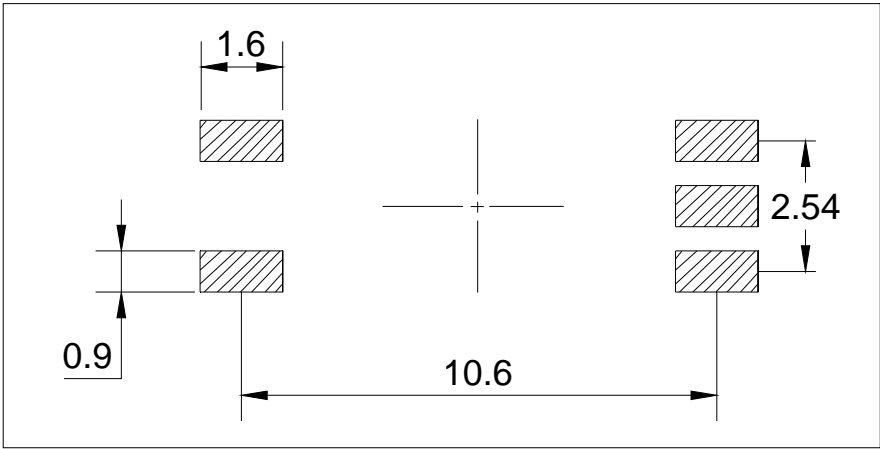
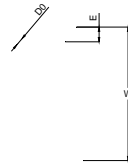
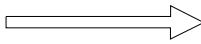
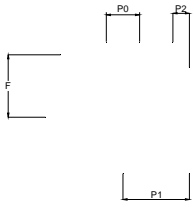

Fig.9: Switching Time Test Circuit and Waveform



Dimensions					
Millimeters			Inches		
Min.	Typ.	Max.	Min.	Typ.	Max.
7.40		7.80	0.291		0.307
3.40		3.80	0.134		0.150
0.00		0.20	0.000		0.008
1.80		2.20	0.071		0.087
8.10		8.70	0.319		0.343
0.40		1.00	0.016		0.039
9.90		10.50	0.390		0.413
0.10		0.30	0.004		0.012
1.80		2.40	0.071		0.094
0.25		0.55	0.010		0.022





TT^T

Ref.	Dimensions					
	Millimeters			Inches		
	Min.	Typ.	Max.	Min.	Typ.	Max.
D0		1.55	1.60		0.061	0.063
P0	3.90	4.00	4.10	0.154	0.157	0.161
P1	7.90		8.10	0.311		0.319
P2	1.90	2.00	2.10	0.075	0.079	0.083
E	1.65	1.75	1.85	0.065	0.069	0.073
F	7.40	7.50	7.60	0.291	0.2	0.299
T	0.35	0.40	0.45	0.014		0.018
W	15.80	16.00	16.20	0.622	0.630	0.638

4.1014 > .00

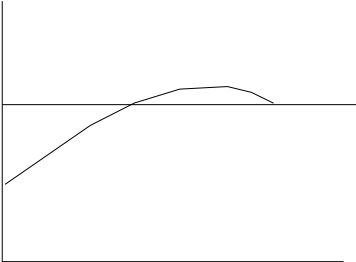

Note:

1. Reflow soldering is recommended at the temperatures and times shown, no more than three times.
2. Avoid direct contact between the epoxy body and any tools or surfaces exceeding its maximum