



- 2 & ' \$ \$ % :

5HY \$

^ Z/Wd/KEW

7KH SURGXFWV D B S W D W R X S O L H U H U L Q
 :623 SDFNDJH 7KHQQVH V W F H R F R D Q L Q I U
 R S W L F D O O \ F R X S O W B G W R L D I Q J D Q L W H J L L
 S K R W R G H W H F W R U G H V F J K L D S U D , W S L H R G Y I S I
 D Q G V S H F L I L F D W L R Q V D W W , M P S V L S D X W W
 V P D O O H U D Q G F R P L S O L W Q R V Q D I O W K D I L Q W V
 U H L Q I R U F H G L Q V X O D W H R O V W D W O X H U S
 I R U D S S O L F D W L R Q V W K D W U H T X L U H V
 L Q W H U Q D O Q R L G H H V V D L J X O G D S Q V R M H G F R
 W U D Q V L H Q W L P P X Q L W \ L R I L " G H D D M R U V
 D Q G S R Z H U 0 2 6) (7 J D W H G U L Y H 7 K H S
 L Q L Q G X V W U L D O L R Y G U L W H U V , * 2 6 7 (7 D
 L Q G X F W L R Q F R R N W R S D Q G K R P H D S S O

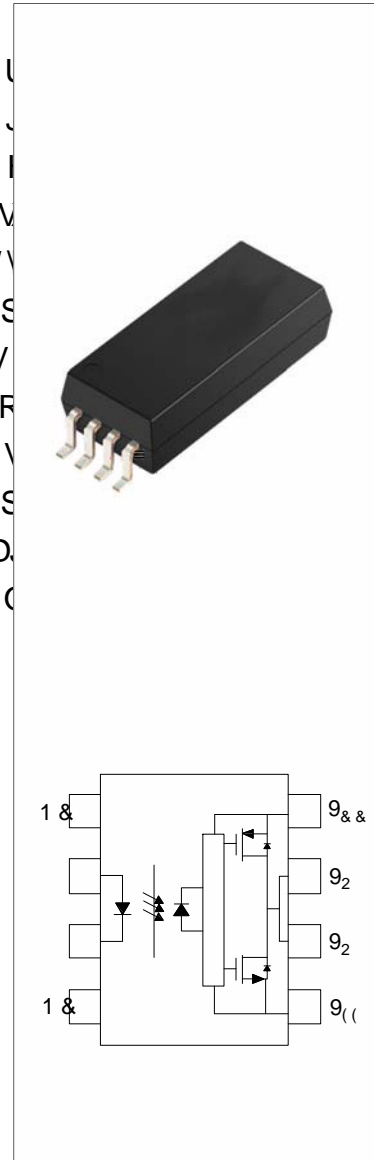

RU
 OXWLR
 UG FHU
 * % 7
 ZLGHO

D /E & dhZ ^

\$ PD[LPXP SHDN RXWSXW FXUUHQW
 +LJK LVRODWLRQ 9506
 %XIIHU ORJLF W\SH
 2SHUDWLQJ W H P S O L J H D W X J L W R f &
 5(\$&+ 5R+6 FRPSOLDQFH
 +%0 + \$ 00 0 &'0 &
 &4& DSSURYHG
 9'(DSSURYHG
 8/ DSSURYHG

dOE μšZ d o

/(' 2)) 21 21 21	9& 9(3RVLWLYH	9& 9(*RLQJHJDWLYH	*RLQJ 2XWSXW /RZ /RZ 75\$16,7,21 +, * +
2))	9	9	/RZ
21	9	9	/RZ
21	9 9	9 9	75\$16,7,21
21	9 9	9 9	+, * +



^K>hd D y/DhD Z 7HPSHUDWXUH f&

3DUDPHWHU		6\PERO	9DOXH	
/(')RUZDUG &XUUHQW)		
	3HDN)RUZDUG &XUUHQW	3	7	\$
	5HYHUVH 9ROWDJH	95		
	3RZHU 'LVVLSDWLRQ	3		P:
'HWHFWRU	2XWSXW 9ROWDJH	2	9	
	6XSSO\ 9ROWDJH	9&		
	3RZHU 'LVVLSDWLRQ	3&		P:
,VRODWLRQ 9ROWDJH		9LVR	8	9UPV
2SHUDWLQJ 7HPSHUDWXUH		7RSU	a	
-XQFWLRQ 7HPSHUDWXUH		7M		
6WRUDJH 7HPSHUDWXUH		7VWJ	a	
7RWDO 3RZHU 'LVVLSDWLRQ		3WRW		P:
6ROGHULQJ 7HPSHUDWXUH		7VRO		

8QL

EKd ïï • %µο• U ïï, ï (œ µ v Ç
EKd î (}œ íu]vµš U ZX,XAđì•òì9

> dZ/ > , Z d Z 7HPSHUDWXUH f&

3DUDPHWHU	6\PERO	&RQGLWLRQ	0LQ	7\S	
)RUZDUG 9ROWDJH)) 9P\$,			9
,Q SXW 5HYHUVH &XUUHQW p# &3H 1Är\$ (#7P)P)P)P)P) P u €P`WD3H0•					

0I



- 2 & ' \$ \$ %

Z Œ š Œ]•š] • μŒÀ •

),*)RUZDUG &XUUHQW YV)RUZDUG* 900WDSORZDEOH /(')RUZDUG YV \$PELHQW 7HPSHUDWXUH

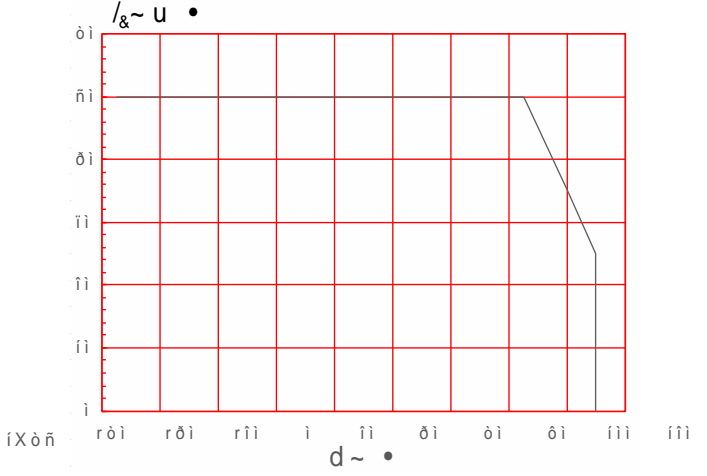
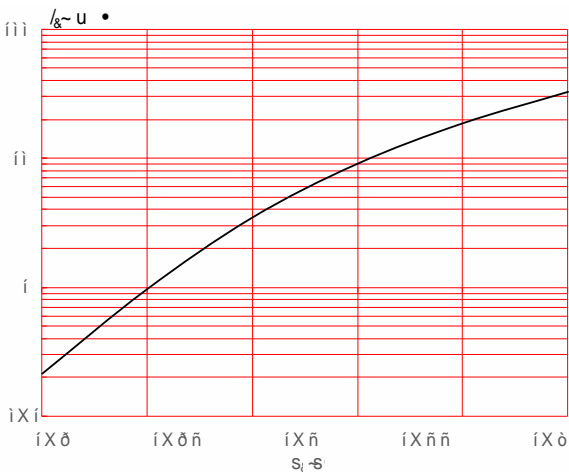

),* &ROOHFWRU 3RZHU 'LVVLSWLRQ* YV K\$PELHQW ,QSXW &XUUHQW 7HPSHUDWXUH

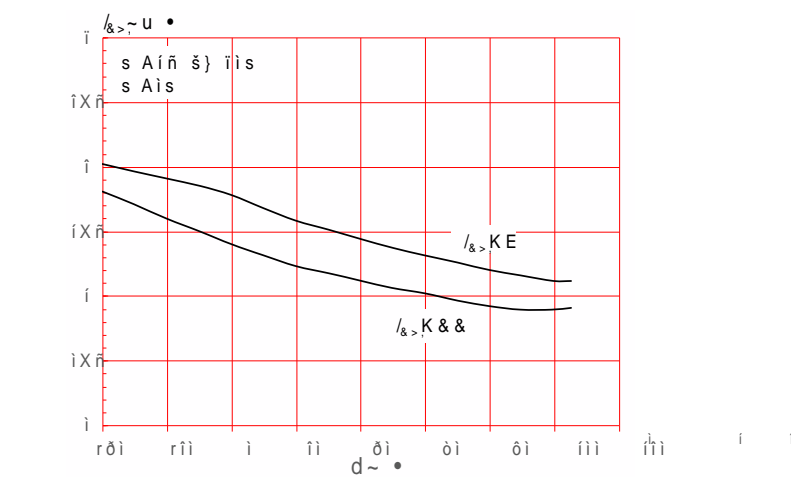
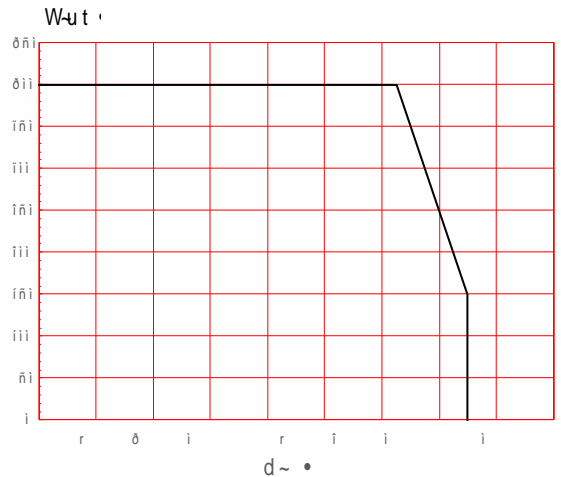

),* /RZ OHYHO 6XSSO\ &XUUHQW YV \$PELHQW \$PELHQW 6XSSO\ &XUUHQW 7HPSHUDWXUH

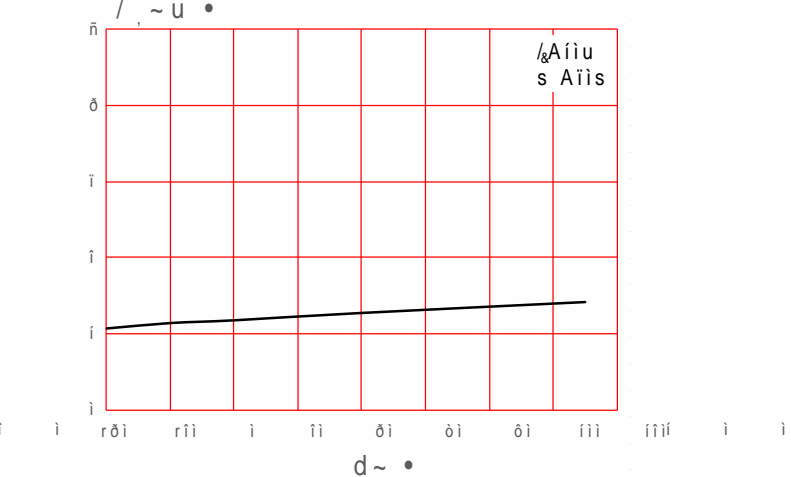
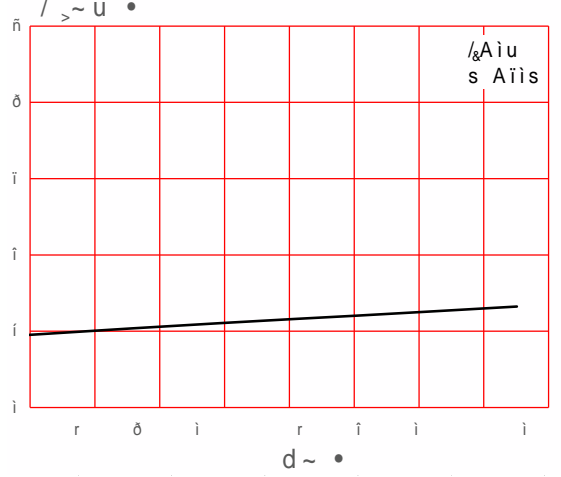

- 2 & ' \$ \$ %



- LH - LH 0LFURHOHFWURQL

), * /RZ OHYHO 2WVSHXWV9R\$CP ELHQW, * +LJK OHYHOR 2WVSHXWV9 \$PELH
7HPSHUDWXUH 7HPSHUDWXUH

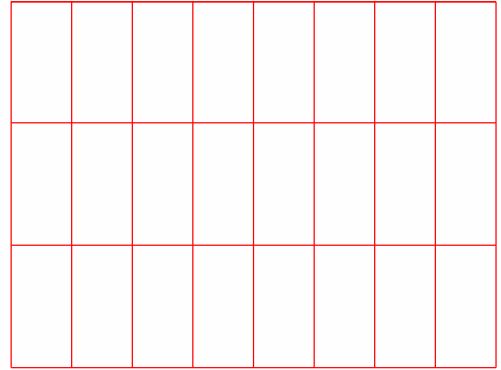
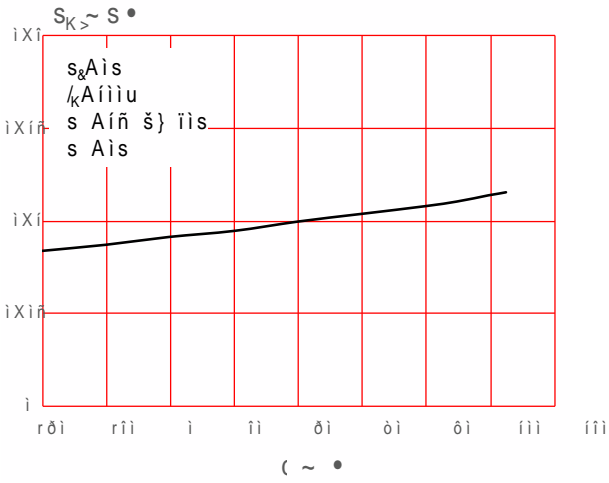

- 2 & ' \$ \$ %

W I P] u v •] } v ~ h v] š W u u •

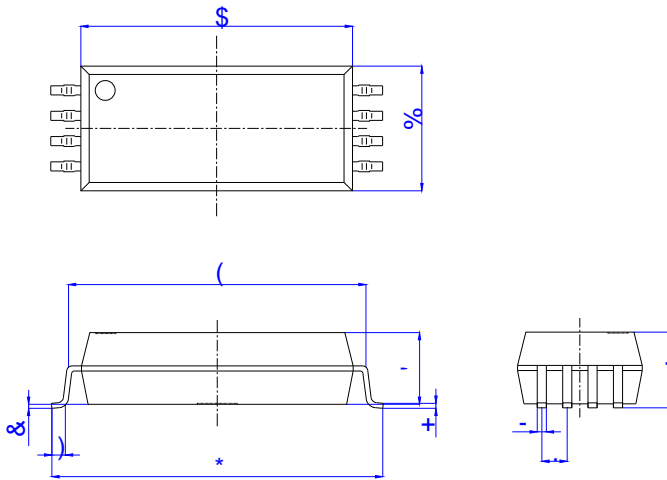

5 HI	'LPHQVLRQV					
	0LOOLPHWHUV			,QFKHV		
	0LQ	7\ S	0D[0LQ	7\ S	0D[
\$						
%						
&						
'						
(
)						
*						
+						
,						
-						
.						

- 2 & ' \$ \$ %

 - LH - LH 0LFURHOHFWURQL

ZZ / Z d W ^W / & / d / k / E / ^ / } v] u u μ ν o • • • š š ž Ć Á] •

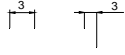





Z & > Kt / E & KZD d / KE

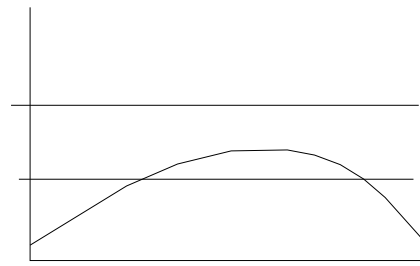
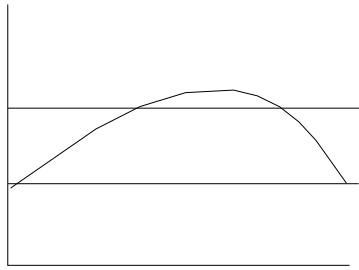



1RWH

5HIORZ VROGHULQJ LV UHFRPPHQGHG/ DWKRVZQH QVHPSHWDWIXDQW XW
\$YRLG GLUHFW FRQVWDHFWRPHQVZDQWXPUDFRU H[FHHGLQJ LWV PD
VWRUDJH WHPSHUDWXUH

\$SSOLFDWLRQ RKHUSRYXENRQLWLSOHGDDWHG WHPSHUDWXUHV ,QV
VFHQDULRV DQHPSVOLGRWRHFFHHG 1

(QVXUH WKH FRPSRQHQW KDV FRROHG SURFHPEHQDQWZLXPSWHUDXHQ
PDQXIDFWXULQJ VWHSV

7KH FRPSRQHQW KDV D VKHOI OLI