

- 2 & ' \$ \$ % ' 3 6 6 H U L H V

5HY \$

^ Z / W d / K E W

7KH SURGXFWV D B S W R W R X S O L H U H L Q D S O D V W L F
 ', 3 S D F N D J H Z L W K G R U P I U Q I Q W S O H L R Q V 7 K H G H Y L F H
 F R Q V L V W V R I D Q L C F I D O O H E R X ' S B S W W R D Q L Q W H J U D W H G
 P H • R K R P H @ Q D - 2 0 - 2 0 0 0 @ S W R Q D S K D A V E R S @ H A M S U R Y L G H V
 J X D U D Q W H H G S H U I R U L P F D Q W F H R D Q Q D W S W F I P I S H U D W X U H X S
 W R , W L V S K I \ V L F D O O \ V P D O O H U D Q G F R P S O L D Q W Z L W K L O
 V D I H W \ V W D Q G D U G H G V L I R V X O B W L R Q F , W W K X V S U R Y L G H V D
 V P D O O H U I R R W S U D S S O L F P D V L R Q R Q W R D W U H T X L U H V D I H W \
 V W D Q G D U G F H U W I D D O V L R Q H \$ Q L H O V G H S U R Y L G H V D
 J X D U D Q W H H G F R P P R Q P P R X G L W W U B Q \ V L H Q W L , W
 L V L G H D O I R U V P D Q G S B Q M V 0 * 2 6 7 (7 J D W H G U L Y H
 7 K H S U R G X F W V D U H Q Z L X G H W O L D V C H G Q L Y H \ W H U V , * % 7
 J D W H G U L Y H U V 0 2 8) (0 W D M Q G S E W L R Q F R R N W R S D Q G
 K R P H D S S O L D Q F H V

D / E & d h Z ^

-2&'\$ \$%

-LH-LH 0LFURHOHFWURQL

^K>hd D y/DhD Z 7HPSHUDWXUH f&

8QL

3DUDPHWHU		6\PERO	9DOXH	
/(')RUZDUG &XUUHQW)		
	3HDN)RUZDUG &XUUHQW ₃		7	\$
	5HYHUVH 9ROWDJH	9 ₅		
	3RZHU 'LVVLSDWLRQ	3		P:
'HWHFWRU	2XWSXW 9ROWDJH	2	9	
	6XSSO\ 9ROWDJH	9&&		
	3RZHU 'LVVLSDWLRQ	3&		P:
,VRODWLRQ 9ROWDJH		9LVR	8	9UPV
2SHUDWLQJ 7HPSHUDWXUH		7RSU	a	
				P:

- 2 & ' \$ \$ %

- LH - LH 0LFURHOHFWURQL

+LJK /HYHO 2XWSXW ₂ +9ROWD ₂ JH ₉) P\$	9			9
/RZ /HYHO 2XWSXW ₉ ROWD ₉ JH ₉	2 P\$	9			9
7KUHVKROG ,QSXW ₉ +XU ₉ UHQW ₉	9& 9 9 ₂ U 9	,			P\$
7KUHVKROG ,QSXW ₉ ROWD ₉ JH ₉	9& 9 9 ₂ Ø 9	9			9
6XSSO\ 9ROWD ₉ JH ₉	9&				
89/2 7KUHVKROG	989/2) P\$	9 ₂ Ú 9			9
	989/2) P\$	9 ₂ Ø 9			9

^t/d ,/E' ^W /&/ d/KE

3DUDPHWHU	6\PERO	&RQGLWLRQ	0LQ	7\S	OD
3URSDJDWLRQ 'HOD\ 7LPH WR +LJK 2XWSXW /HYHO	W+	5J &J Q)) : P\$ 9& 9			
3URSDJDWLRQ 'HOD\ 7LPH WR /RZ 2XWSXW /HYHO	W/	5J &J Q)) : P\$ 9& 9			
3URSDJDWLRQ 'HOD\ 'LIHUHQFH %HWZHHQ \$Q\ 7ZR 3DUW	W/ 3W	5J &J Q)) 8: P\$ 9& 9			QV
2XWSXW 5LVH 7LPH	WR	5J &J Q)) : P\$ 9& 9			
2XWSXW)DOO 7LPH	WR	5J &J Q)) : P\$ 9& 9			
&RPPRQ 0RGH 7UDQVLHQW ,PPXQLW\ DW +LJK /HYHO 2XWSXW	80) P\$ 9& 9 7D 9 ₂ PLQ 9&0 9SS			N9 V

&RPPRQ 0RGH 7UDQVLHQW ,PPXQLW\ DW /RZ /HYHO 2XWS) P\$ 9&& 9 7D 92 PD[9 9&0 9SS	"			N9 V
---	---	---	--	--	------

oo dÇ%] o Àîñµ • š d

E}š W /v%µš •]Pv o ~(Aîñl, ÌU µšÇAñ]i•9 b š•CEšAZš (vA ññv •%)CE ÁoZ }•Z X]v
 %oCE} v •šCE Ç Á]CE]vP %o]š v X
 E}š W ,D]• šZ u Æ]uµu OE š }((oo } (šZ }uv}v uµ•š Àyoš Á]šZ
 šZ }µš%µš À}oš P]v šZ ÚáÞB]XZ]PZ •š š ~sK , b

à0 v ~X

-2 & ' \$ \$ %

-LH-LH 0LFURHOHF WURQL

KZ Z/E' /E&KZD d/KE

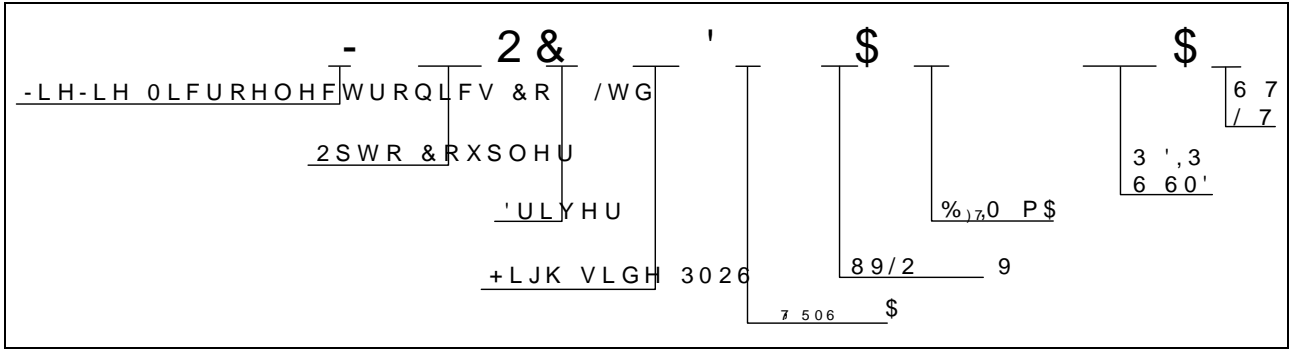

W I]vP Yμ vš]šÇ	
K% š]}v	Yμ vš]šÇ
/W	ñi hv]š•ldμ
^D	íîî hv]š•lZ o

D Z</E'

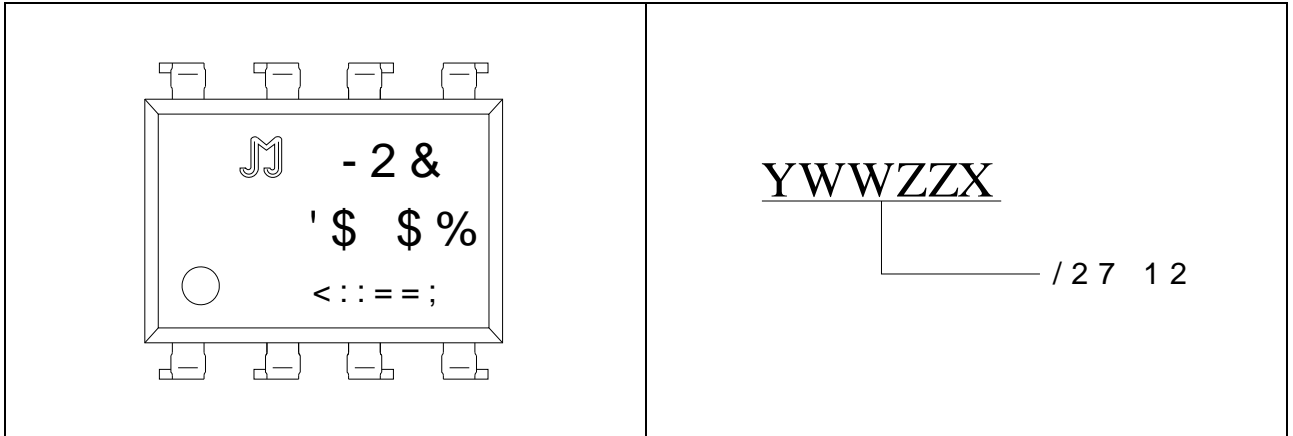

Z Œ š Œ]•š] • μŒÀ •

),*)RUZDUG &XUUHQW YV)RUZDUG* 900WDSORZDEOH /(')RUZDUG YV \$PELHQW 7HPSHUDWXUH

iii /&~u •

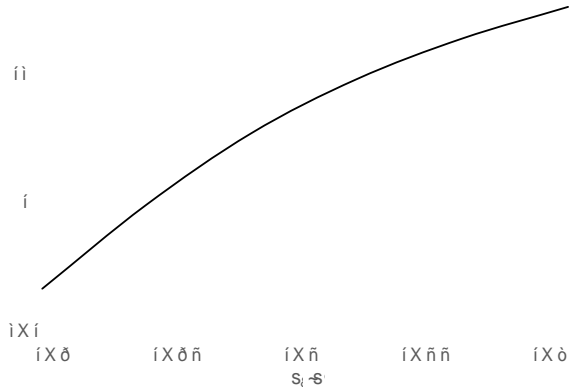

öi /&~u •

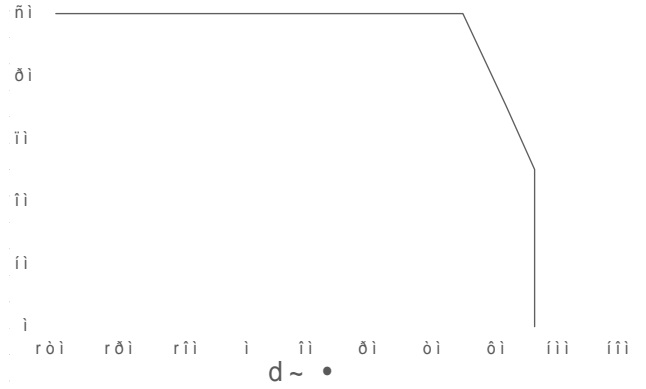

),* &ROOHFWRU 3RZHU 'LVVLSWLRQ* YV K\$PELHQW ,QSXW &XUUHQW 7HPSHUDWXUH

Wut'

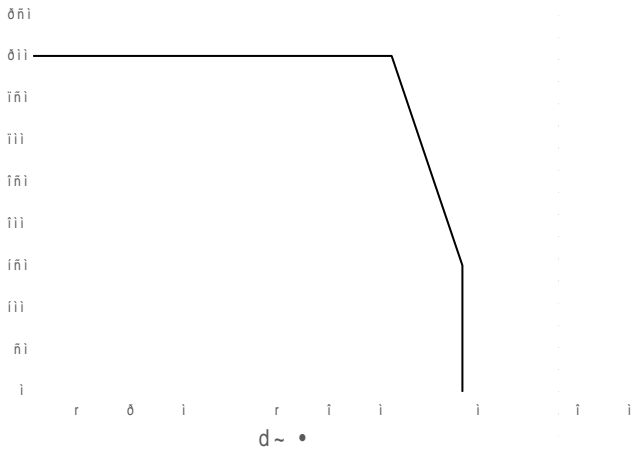

/&>~u •

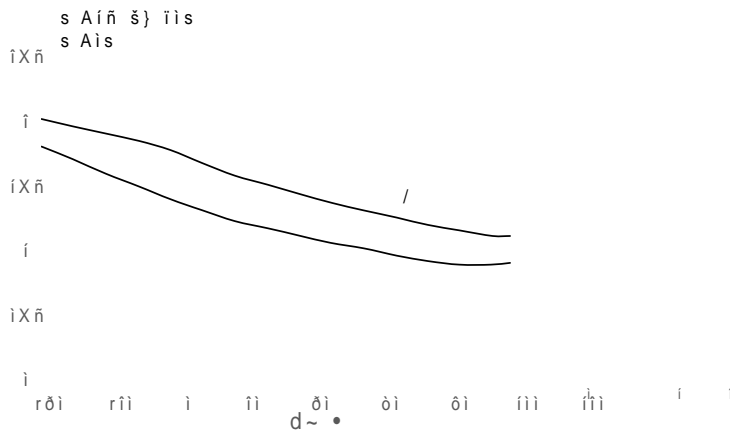

- 2 & ' \$ \$ %

- LH-LH 0LFURHOHFWURQL

), * 3URSDJDWLRQ 'HOD\ 7LPH YV 6XSSO\
9ROWDJH

iii $\checkmark_{V>}$ U $\checkmark_{V>}$ V •

dAin U (Aii, iU μ šÇAñi9
ZPAiiOU P $\checkmark_{V>}$ U /

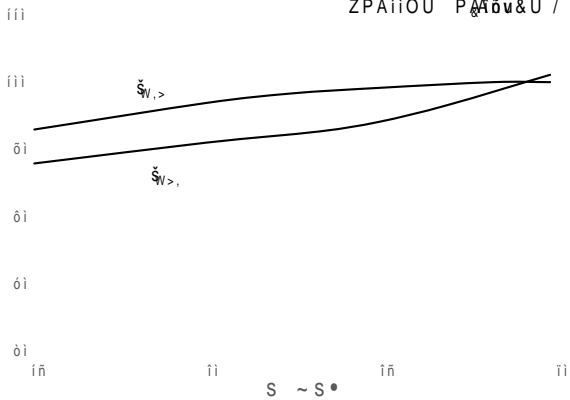

d • š]OE μ]š •

), * 6ZLWFKLQJ 7LPH ~~X~~HW ~~W~~Q :DYHIRUP

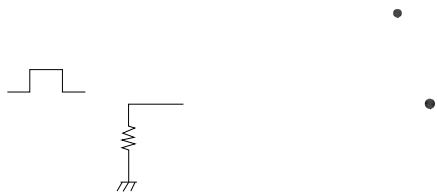

W I P] u v •] } v ~ h v] š W u u •

6WDQGDUG ', 3 7 \ S H

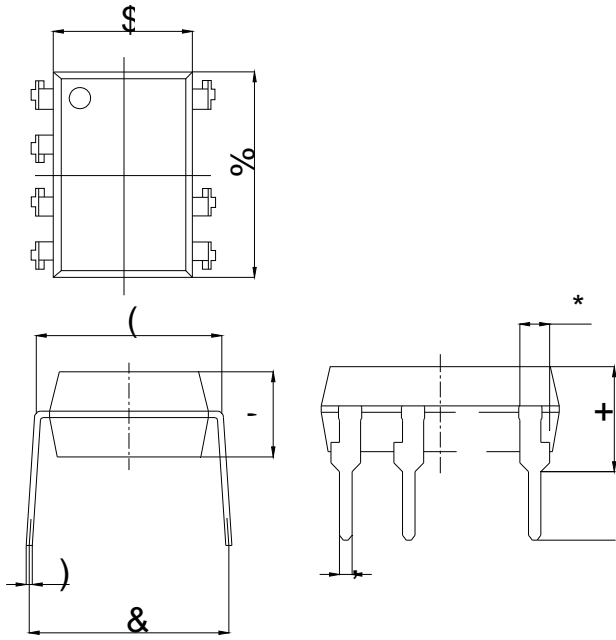

5 HI	'LPHQVLRQV				
	0LOOLPHWHUV , QFKHV				
	0LQ	7 \ S	0D[0LQ 7 \ S	0D[
\$					
%					
&					
'					
(
)					
*					
+					
,					
-					

Z KDD E ^K> Z D ^< ~]u v•]}v•]v uu μvø •• }šZ Œ

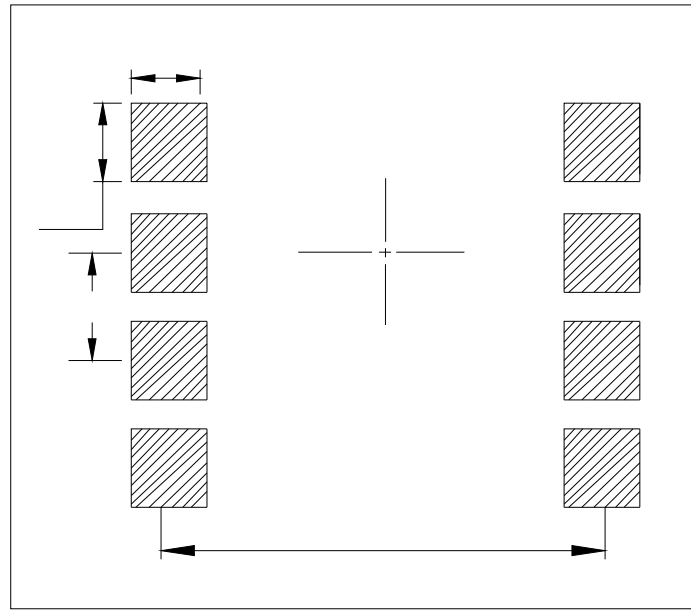

dh ^W /&/ d/KE^ ~]u v•]}v•]v uu μvø •• }šZ ŒÁ]•

6WDQGDUG ',3

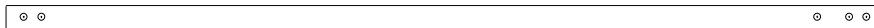
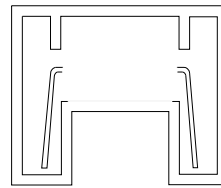
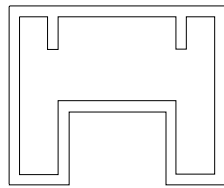

ZZ/ Z d W ^W /&/ d/ (E) ^ }v]uu μνo •••ššž ĆÁ]•

2SWLRQ 6 /

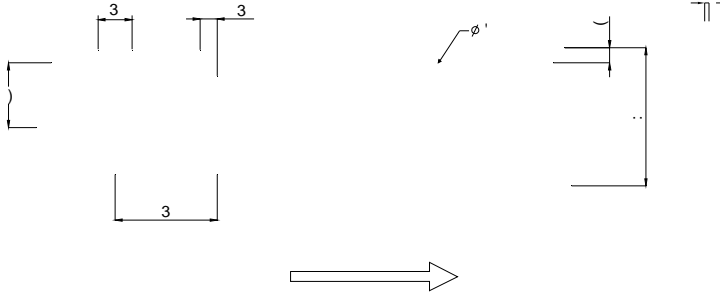

5 HI	'LPHQVLRQV					
	0LOOLPHWHUV ,QFKHV					
	0LQ	7\ S	0D[0LQ	7\ S	0D[
,						
3						
3						
3						
(
)						
7						
:						

- 2 & ' \$ \$ %

- LH - LH 0LFURHOHFWURQL

t s ^K> Z/E'

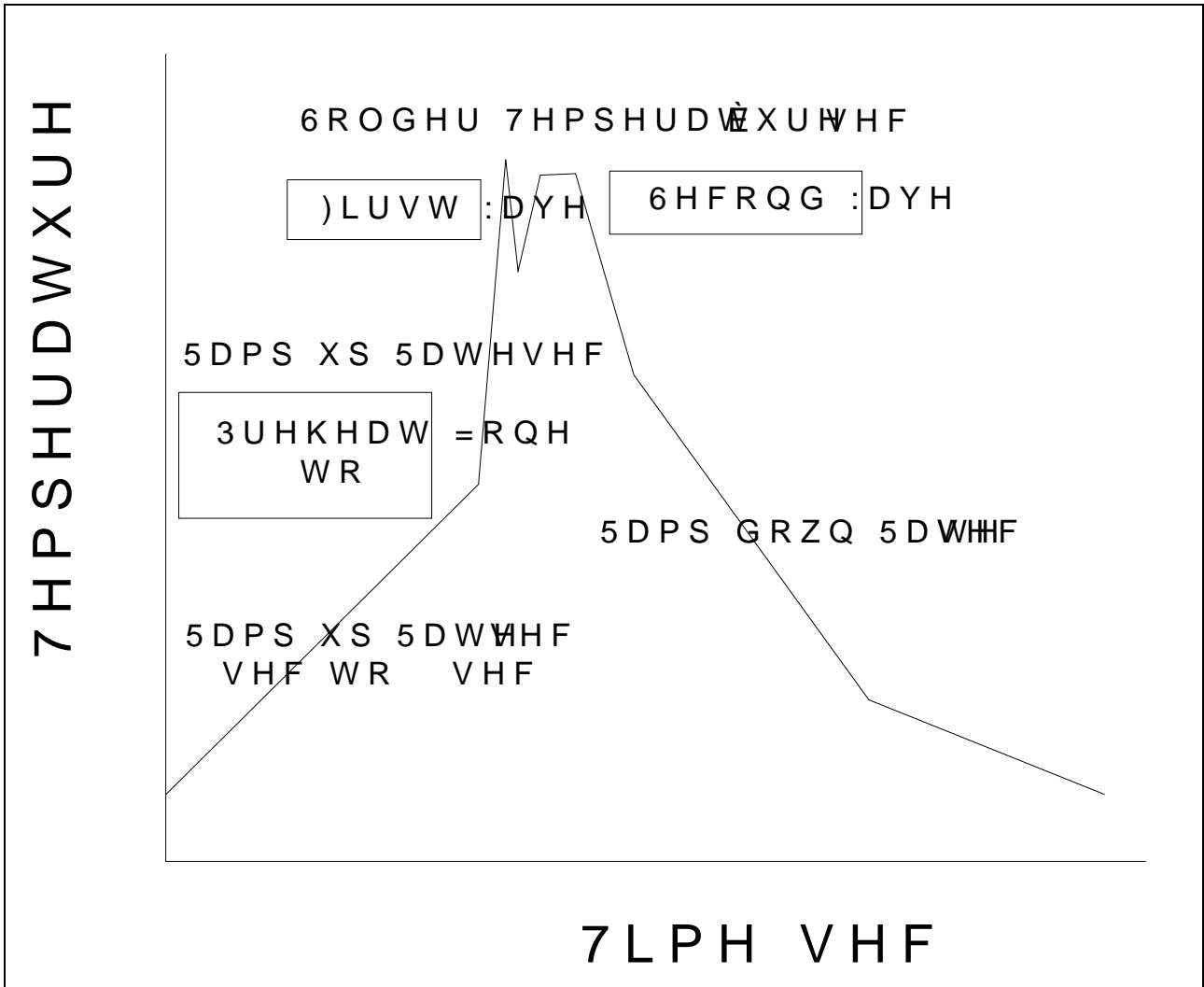

, E ^K> Z/E' z ^K> Z/E' /ZKE

6ROGHULQJ 7HPSHUD	DWXUH	f
6ROGHULQJ 7LPH		V PD[

- 2 & ' \$ \$ %

- LH - LH 0LFURHOHFWURQL

1RWH

5HIORZ VROGHULQJ LV UHFRPPHQGHG/ DWKRVZQH QVHP\$UUDWIKDQ WKO
\$YRLG GLUHFW FRQVWDIFSRPHQZDQ QWXRUDFRU H[FHHGLQJ LWV PD